

Article number: 0106032

Description: Retaining ring JV 16

Measures

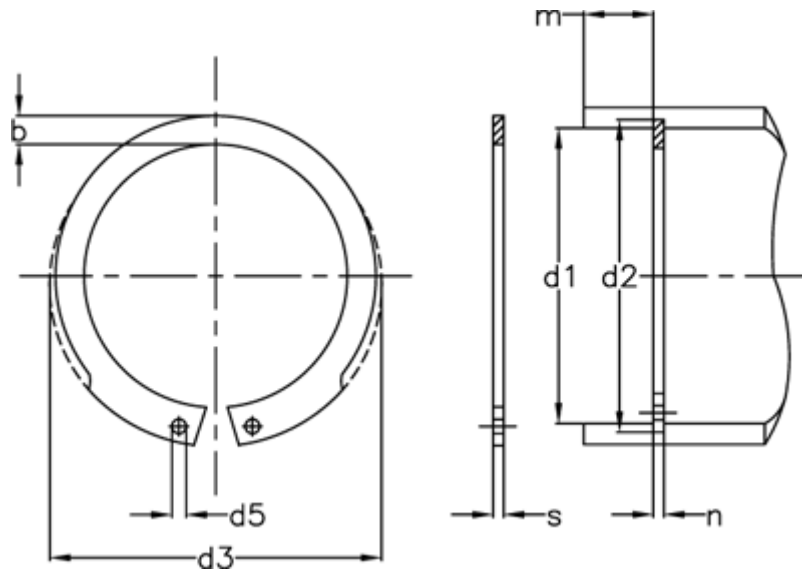

AN mm ²	= 10	FRg kN	= 3.1	tol	= 0.1
b	= 2.1	FR kN	= 5.2	tol	= -0.06
d1	= 16	g	= 1.0	tol	= +0,42-0,13
d2	= 16.8	K kN-mm	= 22.7	tol	= +0,11
d3	= 17.3	m min	= 1.10	Tong	= ZGJ-1
d5 min	= 1.3	Nominal drive	= 1.2	Weight kg/1000	= 0.53
Description	= JV 16	s	= 1.00		
FN kN	= 1.67	t	= 0.40		